







产品描述		
类型	24 / 21	-
	24 / 28	■
内置式钢芯	3 mm	■
2件式尼龙盖把手		■
内置式螺栓固定		■
各规格垫片可用	1 mm	-
	2 mm	-
	3 mm	■
■ 适用    - 不适用    □ 定制		



		
白 RAL 9016*	深灰 RAL 7030 / 7038*	红 RAL 3003*
		
深蓝 RAL 5011 / 5013*	蓝 RAL 5002*	黑 RAL 9005*

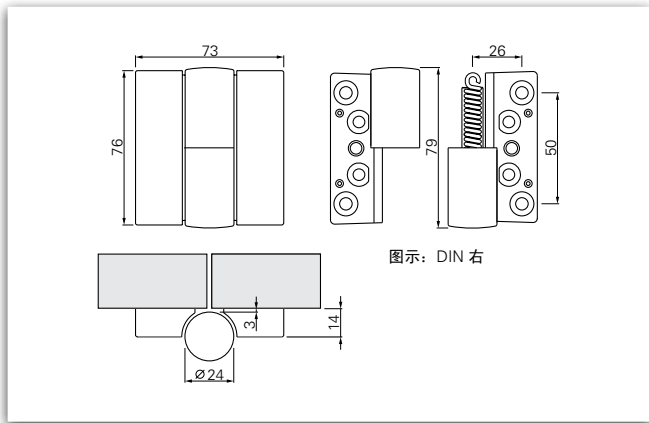

Ku



尼龙弹簧铰链 / 非企口门尼龙铰链	货号	描述	材质
尼龙弹簧铰链	260600	24 / 28 DIN 右侧	尼龙
尼龙弹簧铰链	260605	24 / 28 DIN 左侧	尼龙
垫片	260384	3 mm / DIN 右侧	
垫片	260383	3 mm / DIN 左侧	