

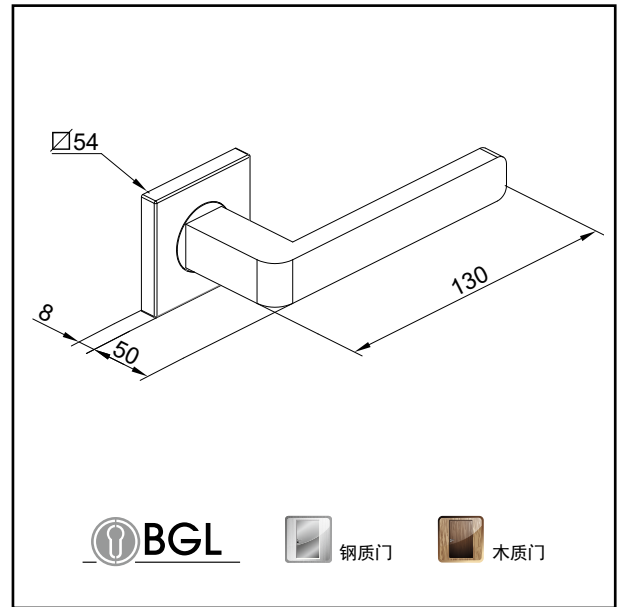



D-2670

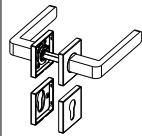

D-2670 经济型把手

- 复位弹簧结构, 操纵平稳, 使用寿命可达10万次
- 左右手门通用
- 对穿螺丝固定, 连接牢固
- 可选标准门厚范围40-60mm, 可定制特殊门厚规格
- 不锈钢304材质, 缎纹拉丝表面
- 多种组合方式可选

D-2670 把手			分体式把手
			
	19 mm	8 mm	